

FLUENCE

BY OSRAM

VYPR 2x
VYPR 2p

MOUNTING INSTRUCTIONS



MOUNTING

VYPR Series fixtures ship with your choice of hanging hardware. To mount your VYPR fixture, start by identifying a suitable support structure to hang your fixture from. Each VYPR fixture weighs 7 lbs 5 oz. Common support structures include Unistrut, trusses, pipes and structural channel.

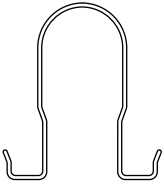

PIPE BRACKETS

Ideal for pipes up to 1 3/8" in diameter

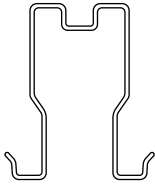

UNISTRUT BRACKETS

Ideal for standard 1 5/8" wide Unistrut or U-Channel

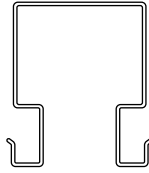

SQUARE BRACKETS

Ideal for all structural channel up to 2 3/4" wide

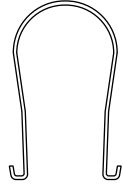

POWER SUPPLY ENCLOSURE BRACKETS

Ideal for pipe and Unistrut up to 2 3/4" wide

MOUNTING WITH PIPE, UNISTRUT & SQUARE BRACKETS

- 1 Start by hanging the bracket over the support structure supporting the end of your VYPR fixture under the bracket.
- 2 While maintaining a firm grip on both the bracket and fixture, pinch the bottom sides of the bracket inward, insert the bottom of the bracket into the top of the VYPR heatsink between the fins and release tension on the bracket.

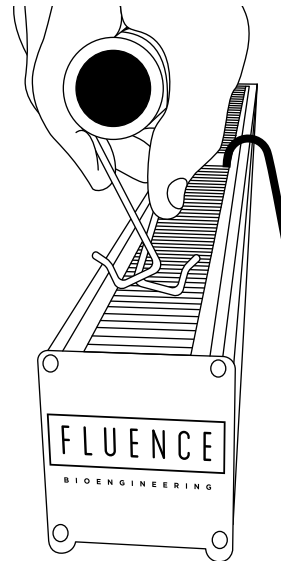
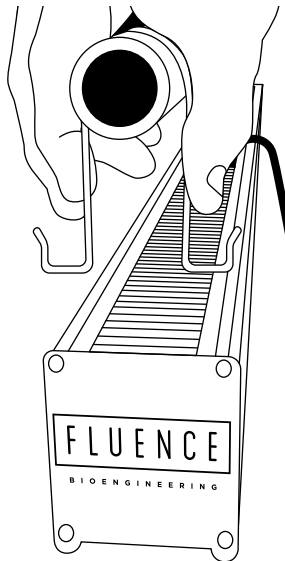

3 When installed properly, the bracket should hook into both sides of the heatsink frame to provide a level and secure mount.

4 Repeat steps 1-3 on the other side of the fixture to finish mounting your VYPR. Please ensure brackets are spaced at least 30" apart and are centered relative to the fixture.

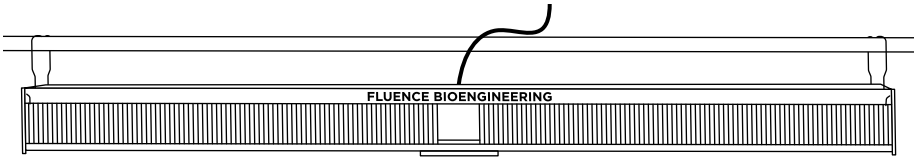
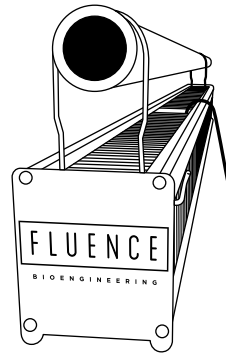

MOUNTING THE POWER SUPPLY ENCLOSURE

1 Start by identifying the mounting bracket holes on the narrow side of the power supply enclosure. There are a pair on each side to receive two hanging brackets.

2 While maintaining a firm grip on both the bracket and the power supply enclosure, pinch the bottom sides of the bracket inward and insert into the receiver holes on the power supply enclosure and release tension on the bracket.

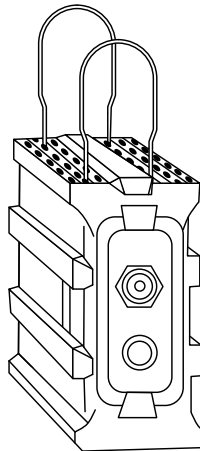
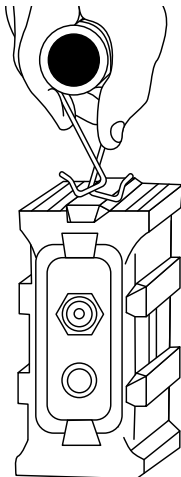
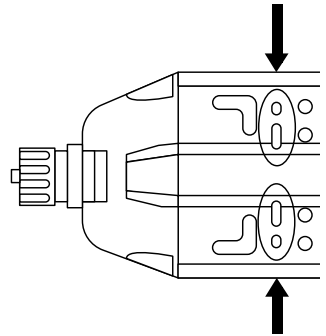

HOW TO APPLY YOUR VINYL-CUT FLUENCE STICKER

- 1 Clean and dry the surface where the sticker will be applied.
- 2 Remove backing sheet to expose adhesive and apply sticker to desired surface.
- 3 Starting from the center and working outward, squeegee pre-masked surface with a credit card to remove air bubbles.
- 4 Allow adhesive to bond approximately 15 minutes before removing the back of the sticker at a 45° angle, keeping it as close to the sticker as possible. If lettering is coming up with back, re-squeegee before attempting to remove.



**Last, and most important,
please recycle all packaging material.
Future generations will thank you.**

FLUENCE

BY OSRAM

Review our products, share your grow and stay abreast of the latest Fluence news and product releases through the channels below:



512.212.4544 • fluence.science

© Copyright 2018. Fluence Bioengineering, Inc.
Version 2.0 • 11.2018 • 71127A